

WICANDERS WISE

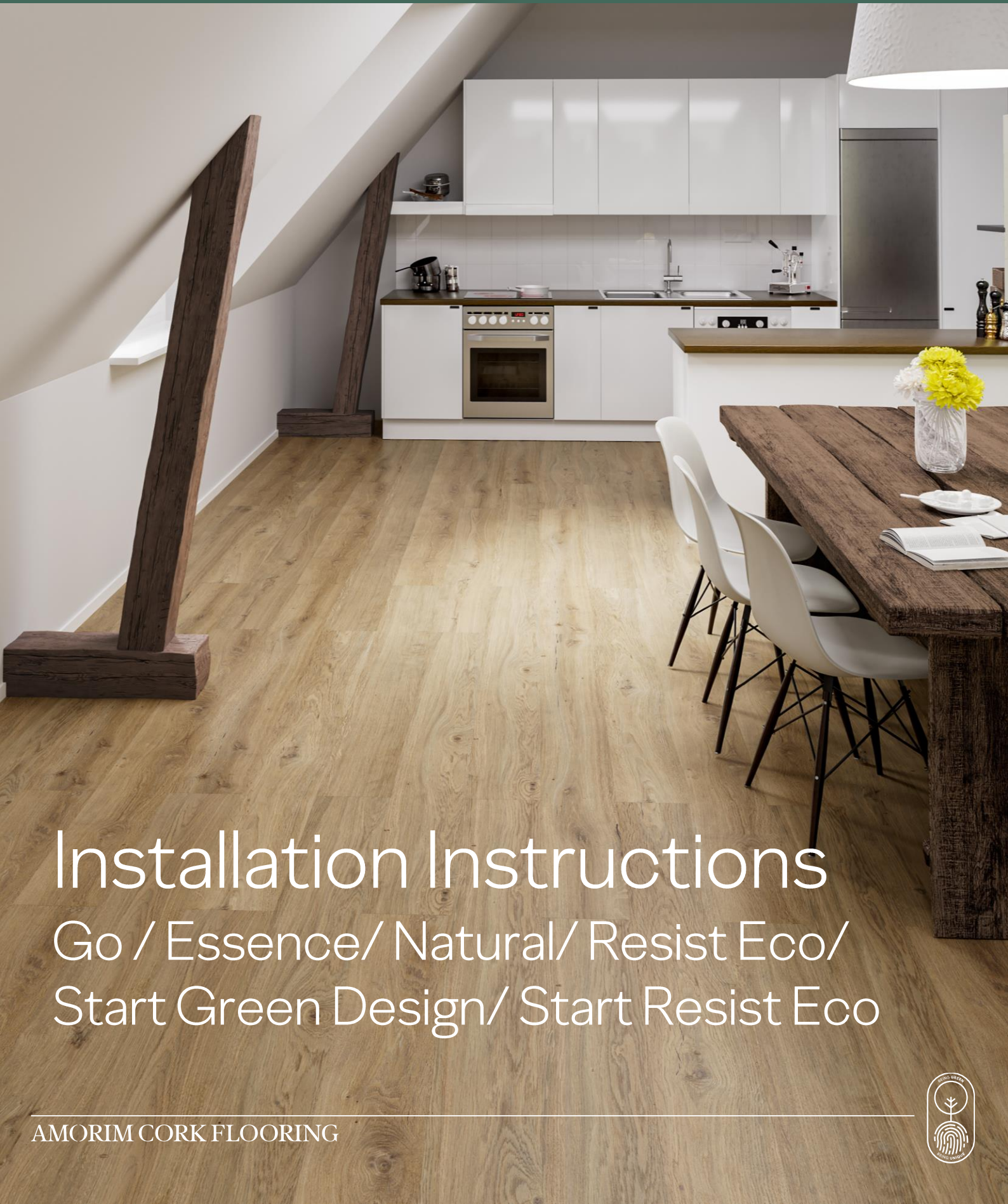

Installation Instructions Go / Essence/ Natural/ Resist Eco/ Start Green Design/ Start Resist Eco

Transport, storage, and acclimatization Transport and store the cartons horizontally. Packed tiles must be acclimatized at the job site in a dry, well-ventilated area for a minimum of 48 hours so that flooring may acclimate. Do not stack more than three cartons high and leave 15 cm (6 inches) between stacks. Remove tiles from packages just before starting the installation. During storage and installation, maintain temperature and relative humidity to a level consistent with the conditions which will prevail when the building is occupied. This means maintaining a temperature range from 18°C to 28°C (65°F to 82°F) and relative humidity range from 35% to 65%. In order to reach this climate, use heating or air conditioning or humidifier in the appropriate duration of time before starting the installation. Wicanders Wise shade variation is an inherent and attractive characteristic. To achieve the most pleasant blend of shades, shuffle the planks before installation.

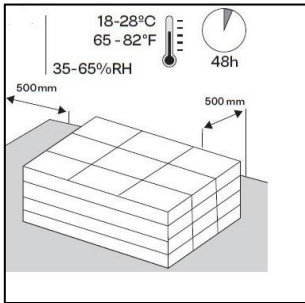

Adequate product choice for use or site conditions: Wicanders Wise can be installed in all domestic areas and in most commercial areas, except in saunas, bathrooms, and permanent wet areas. Wicanders Wise floors are suitable for indoor use only. Please consult our Warranty to confirm if this product is adequate for the intended use considering the applicable structural, wear and product class.

Site inspection: Prior to installation, please inspect the tiles in daylight for any visible faults or damage, and also check if the subfloor and site conditions are in accordance with the specifications described within these instructions. Amorim Cork Flooring cannot be held responsible for claims associated with improper subfloors, improper applications, adhesives, varnishes, and the use of maintenance products not recommended, or detectable defects verifiable prior to installation.

Subfloor requirements: All types of subfloors must be even, flat and level, dry, and variations should not exceed 3mm in 2m (3/16" in 6 1/2 feet). Wicanders Wise floors are suitable for indoor use only. Wicanders Wise can be installed on top of most hard surfaces such as resilient floor coverings and ceramic tiles which are sufficiently fixed, completely levelled and have no loose areas. Soft subfloors such as carpets and similar must be removed. For Wicanders Wise installation no underlay is required.

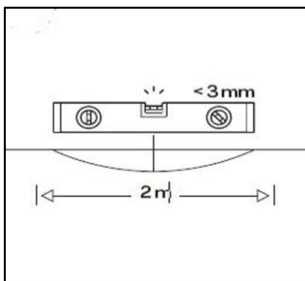

UNDERLAY: As the Wicanders Wise already have a pre-attached cork underlayment, an additional cork underlay is not required. However, in order to improve comfort, acoustic performance and for other reasons, the best results can be expected with a cork underlay that supports the click system during daily use. Our recommendation for underlays: GO4CORK Unique. If the customer prefers to use other underlays than the ones recommended by us, they must comply with the following technical characteristics:

DL ₂₅	Sustained load generated by walking etc.	≥ 10,000 Cycles	≥ 100,000 Cycles
CS	Compressive strength at a defined compression stress	≥ 10 kPa	≥ 60 kPa
CC	Sustained load generated by furniture etc.	≥ 2 kPa	≥ 20 kPa

Some underlays require the use of a moisture damp proof membrane (PE foil). Please check the underlay's supplier instructions and/or technical data sheet. The use of underlays that do not meet these requirements may damage the floating floors. Our product warranty shall not be applicable in such cases.

Expansion Gaps: Wicanders Wise floating floors are installed as a "floating floors", so the planks should not be fixed to the subfloor. The skirting boards/mouldings cannot be pressed down, not restricting the movement of the floor. Also provide 5mm (0.2") expansion gaps to the walls and other fixed objects. Skirting boards/mouldings should cover minimum 7mm (0.28") of the floor. Transitions between two rooms and asymmetrical floor areas require extra expansion gaps in floor areas with dimensions bigger than 10m (30 feet) in either length or width (100m² / 1000sq ft).

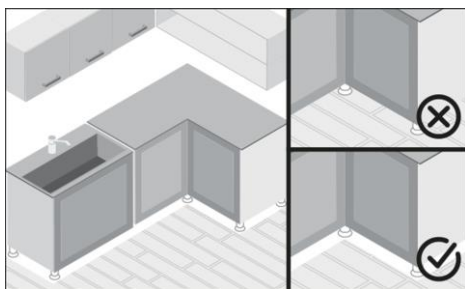
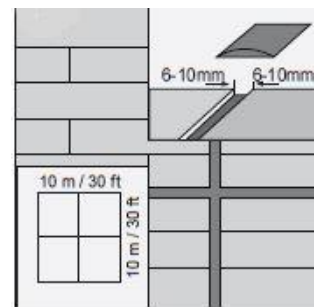

Any permanent and heavy structures like kitchen islands or cabinets should be installed first and not on top of Floating floors, as they should be able to move around such heavy objects, otherwise it could lead to open joints or separating or damaged planks.

Radiant-Heated Subfloors Wicanders: Wicanders Wise floating floors can be laid in combination with floor heating and/or cooling systems. For the heating or cooling systems follow the instructions supplied by the system manufacturer/contractor or contact your supplier. To avoid problems with functioning and durability during the construction phase, follow the norms and rules concerning installation.

Very important for subfloor heating systems: Please take in account that the drying of a heated subfloor must be made by turning the heating on/off with a pause before installation of the floor. After that you can begin the "heating phase". The heating phase must begin with running temperature of 25°C (78°F) for 3 days. The subfloor should be in place and cured for at least 60-90 days. The temperature should then be increased each day until the maximum temperature allowed according to the manufacturer system. This maximum value should be kept for at least 72 hours without turning it off. The decrease of temperature is made by reducing it gradually every day until the surface achieves 18°C (65°F). During the installation, the temperature of the surface should not be less than 18°C (65°F) and should be kept for 3 days after finishing the installation (for floating floors). Then the temperature should be increased slowly to a max. of 28°C (82°F) on the subfloor surface. Remember that rugs or mats placed on top of the floor may function as heat accumulators and will increase the floor surface temperature. Maximum floor surface temperature should not exceed 25°C (78°F).

Very important for cooling systems: The floor cooling systems must be equipped with an advanced control and safety system to prevent internal condensation (dew point regulation). To avoid damage to the floor, the supply temperature of the cooling system must not be reduced below a certain temperature, the so-called dew point temperature. Lower temperatures will produce condensation in the floor and damage the floor covering (e.g. warping, distortion, swelling, gapping). For both heating and cooling systems, make sure that the relative air humidity in the rooms during the heating or cooling season is between 35% to 65% and the temperature of the subfloor (temperature underneath of the floor) between 18-28°C (65°F-82°F).

Wicanders Wise on wooden floor / chipboard / OSB: Wicanders Wise on wooden floor / chipboard / OSB. In case of installation on a wooden subfloor, please remove any existing floor covering first. No signs of mold and/or insect infestations should be visible. Make sure that the plywood and OSB subfloor are mechanically fixed (screw), make sure that they are stable and show no movement anytime and at the same time the joints between the panels are even and firmly closed. Existing laminate flooring, wood planks or engineered wood planks must be free of tensions. If there are any visible open seams and/ or height differences between panels then they need to be entirely removed. Existing wood planks, engineered wood boards, OSB panels, drywall elements etc. must not be covered with PE foil acting as a vapor barrier. The area below the floor should also be sufficiently ventilated in an adequate way (back-vented skirting board) to maintain the equilibrium moisture content of the wood planks, engineered wood boards, OSB panels, drywall elements. The crawl space under the wooden subfloor must be sufficiently ventilated. Remove any obstacles from the crawl space and make sure there is sufficient ventilation (minimum 4cm² (0.62" ²) total ventilation openings per 1m² (3sqft) of flooring). The moisture content of the wood must not exceed 10%.

Wicanders Wise on ceramic tile floors: The maximum joint should not be wider than 2mm (3/32"), and 1mm (1/32") depth. If this is not the case, or if there is any kind of embossing, skim coat the grout lines with a floor leveler).

Installation with direct sunlight: Wicanders Wise flooring must be protected from direct sunlight by the use of curtains and/ or blinds.

Moisture Protection: Despite its age, there is always a risk of moisture in subfloors, so it is necessary to measure and keep recorders of the moisture content of the subfloor. On concrete subfloors without radiant heat, consider the maximum humidity less than 75% RH or conduct calcium chloride moisture tests to ensure that moisture emission levels are less than 3 lbs/1000ft²/24 hours (USA and Canada), or CM Test:

Type Of Subfloor	Moisture content CM% Heated	Non-heated
Concrete	1.5	2.0
Calcium Sulfate/anhydrite	0.3	0.5

Wicanders Wise must not be installed where excessive moisture emissions may exist, in accordance with applicable standards. When it is installed on concrete, ceramics or stone subfloors, an effective moisture damp proof membrane (PE foil) must be used, with SD>75 m (water vapor diffusion resistance), according to EN 16354.

Tools required

Pad saw or a fine-toothed electrical saw, utility knife, spacer wedges, pencil, L square ruler/ straight edge, tapping Block, meter measure / measuring tape

List of tools that might be necessary. This list is not exhaustive and not all tools are needed depending on the type of Wicanders Wise floors to be installed. Protective equipment such as safety goggles, dust mask and gloves when sawing/cutting the planks.)

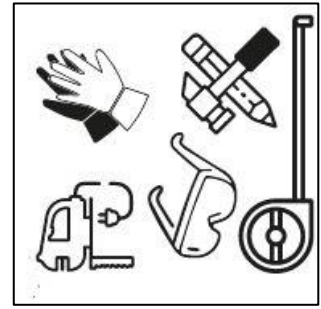

On wooden floors, we recommend laying, Amorim Wise floors crossways to the existing floorboard. Amorim Wise floors locking system are easy to install. We recommend to start installation in the right-hand corner.

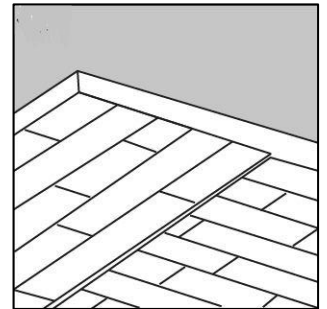

Turn the tongue side of the plank facing the wall.
Maintain a gap of 5mm (0.2") on the short side.

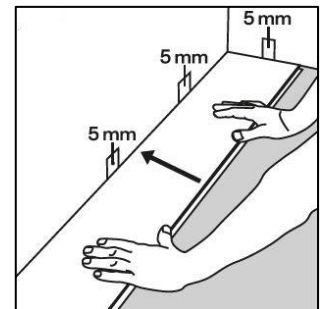

Hold the next plank against the first at an angle to the first one and lay it flat on the floor.
Complete the first row in the same way.



Mark where the plank is to be cut and place it on the work surface and cut to size using any kind of saw.



Cut the final plank of the first row to the correct length.
Place the final plank face down and the short side without the locking strip towards the wall. The distance to the wall should be 5mm (0.2")

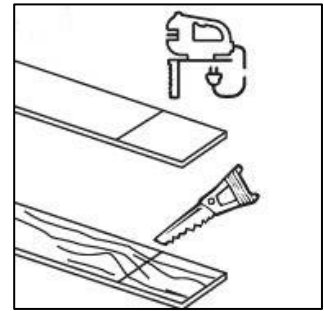

Make sure that the long sides of the planks make a straight line.
Use the cut piece of the plank from the previous row to start the next one.
Always ensure that the end joints are staggered at least 30cm (12") or 1/3 of the board.
If the piece is too short, start with a new board and cut it in half.

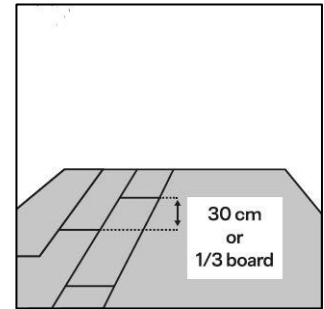

Place the first plank of the new row with the tongue side at an angle against the groove side of the plank in the previous row.
Press forward and lay it flat at the same time.



Place the first plank of the new row with the tongue side at an angle against the groove side of the plank in the previous row. Press forward and lay it flat at the same time.

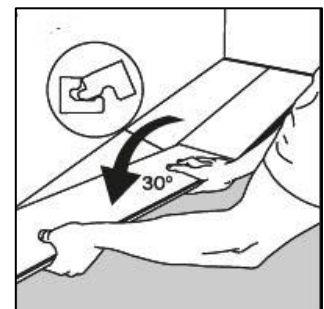

Lift the plank (together with the previous one laid in the same row) slightly up (about 30mm (1.2")), push it against the row in front and then put it down.

Tip: This movement requires some gentle adjustments on the pressing angle.

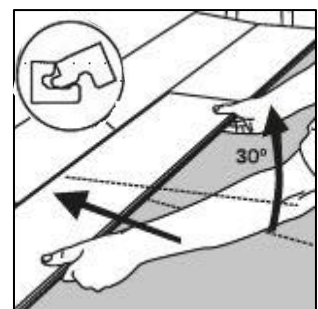

Adjust the distance to the wall to 5mm (0.2") when three rows are complete.

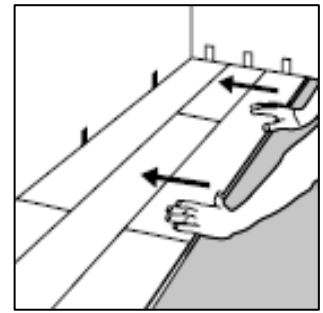

Remaining Rows

Adjust the distance to the wall to 5mm (0.2") when three rows are complete.

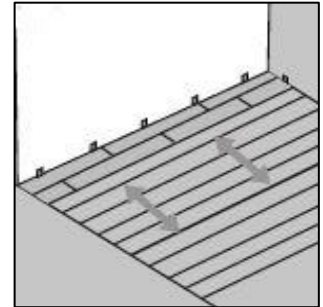

Last Row

Measure and cut the planks in the last row to the correct size.
Allow for a 5mm (0.2") distance to the wall.
No plank should be less than 5cm (2") wide.

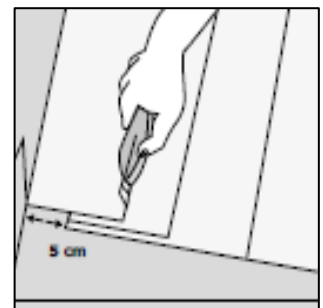

The last and first plank can be cut in the correct width.
Place the last plank on top the second to last plank.
Mark the plank with the help of a piece of plank without locking the strip.
Allow for 5mm (0.2") distance to the wall for the expansion gap.

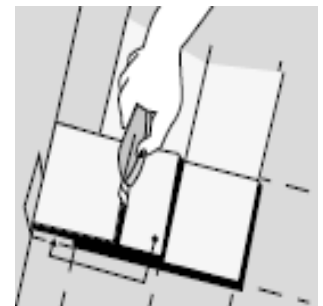

Uneven walls

Sometimes the first row must be cut to match an uneven wall.
Transfer the shape of the wall to the planks. Do not forget to allow 5mm (0.2") to 10mm (0.4") for the expansion gap.
The width of the first row of planks should be equal or bigger than 5cm (2").

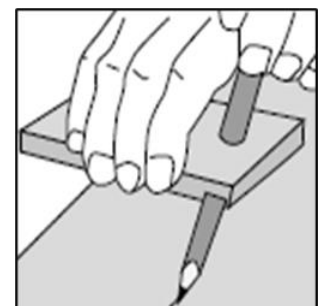

(Installation around doors, radiators and last row)

If you cannot angle the tile under the door frame or a low fitted radiator cut away the locking edge and apply glue (PVA D3 or Isocyanate glue) on the groove and slide the plank into the right position.

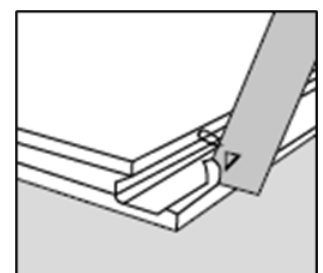

Door frames

If a door frame needs to be cut, use a piece of plank to obtain the correct height.

Saw the door frame and architrave to the required height allowing for 2mm (0.08") of space to the planks. The planks can be laid from all directions. This makes easier to plan the installation e.g. around doors.

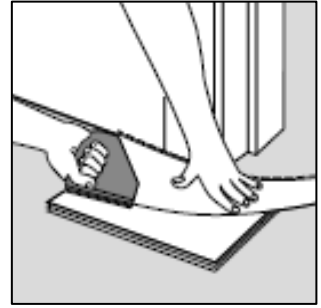

Heating Pipes

Drill the required holes in the planks, making a hole on the plank 10mm (0.4") bigger than the pipe diameter.

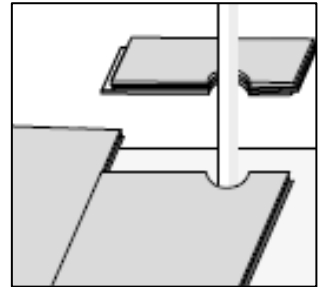

Cut the plank with a 45° angle towards the hole. The cut-off piece is glued in the position again.

Cover the hole with a pipe sleeve.

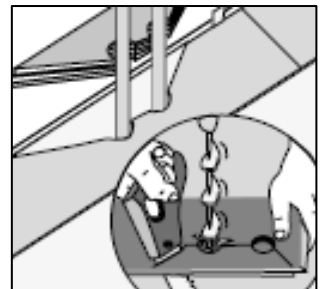

Removing the floor

To uninstall the floor, lift the planks (long side) a few centimetres and then slide the planks on the short side.

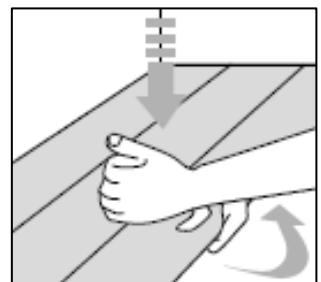

Do not bend connected planks backwards as this will damage it.

